

COUPE A-A

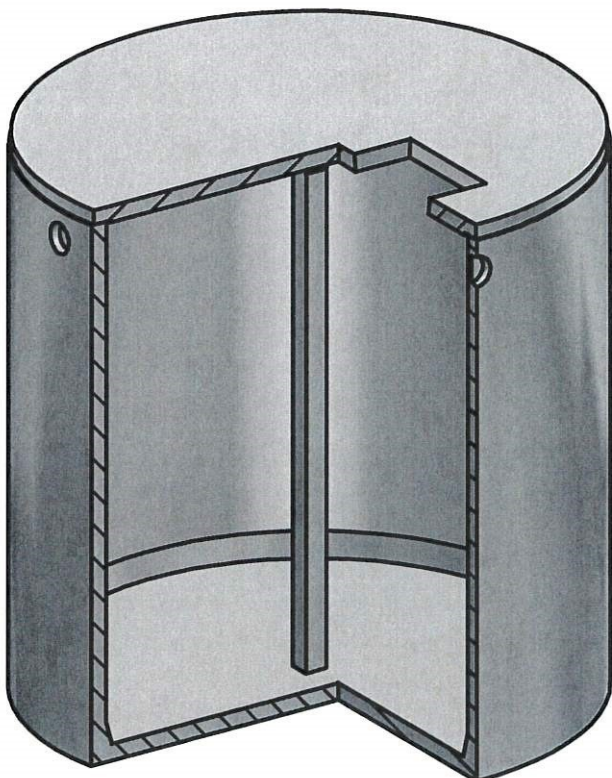

Citerne 10000 Litres Ronde

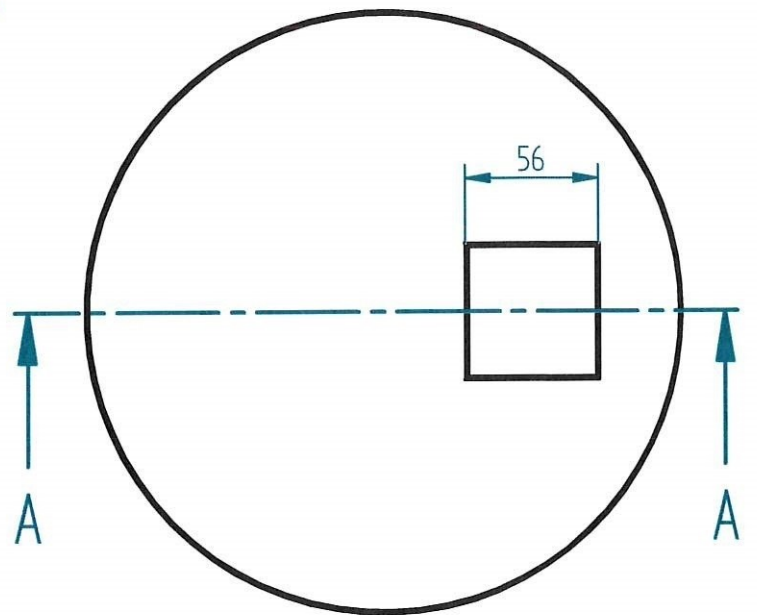

SAS OPALIANS FACILITIES
8 rue de la Fontaine
62250 LANDRETHUN LE NORD

Echelle : 1:30

Poids : 4715 kg

Unités : cm